



# LED Corn Light

## BRIGHTEN YOUR LIFE

NEW LED TECHNOLOGY THAT ALLOWS THE COEXISTENCE OF ENVIRONMENTAL PROTECTION AND ENERGY SAVING

### Benefits

1. MH/HPS/HID/MHL/CFL lamp retrofit
2. Screw Base Direct Install by bypass ballast
3. 100% Die Casting Heat Sink
4. Universal Base E26/E27E39/E40/EX39
5. ETL CETL CE ROHS listed



20W~60W



80W~150W

## Features

1. Beam angle:360 degrees.
2. Aluminum heat sinks and active air exchanging cooling system in order to speed up heat dissipation.
3. It's major to replace the CFL/MH/HID/HPS.
4. Green, energy saving, long and reliable life of 50,000 hours.
5. No RF interference, No IR/UV radiation ,no mercury pollution.
6. Wide colour availability in degrees Kelvin(K),2700-6700K.
7. Streamline exterior design, beautiful appearance.
8. Environment friendly ,energy saving (70~80%).
9. Special circuit design, each LED work separately, avoiding the single broken LED influence problem.



## Application

1. Sports Light/Post Top Light.
2. Flood Light/Pole Light.
3. High/Low Bay Light
4. Roadway Light/Street Light/Billboard Light.
5. Other application roadway.

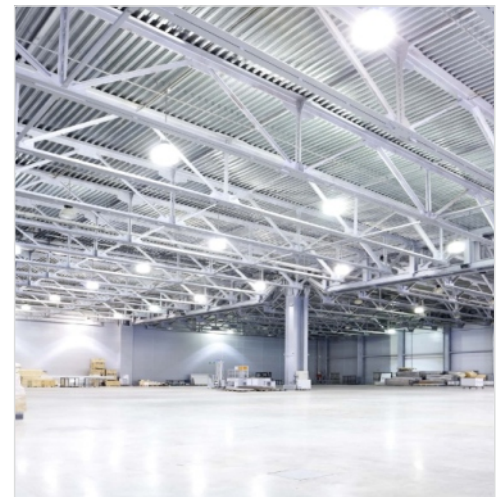

# SPECIFICATIONS

Power	20W	30W	40W	50W	60W	80W	100W	120W	150W
Model	BB-HJD-20W-P	BB-HJD-30W-P	BB-HJD-40W-P	BB-HJD-50W-P	BB-HJD-60W-P	BB-HJD-80W-P	BB-HJD-100W-P	BB-HJD-120W-P	BB-HJD-150W-P
Luminous Flux	2600lm	3900lm	5200lm	6500lm	7800lm	10400lm	13000lm	15600lm	19500lm
Replacement	HPS 50W	HPS 100W	HPS 120W	HPS 150W	HPS 200W	HPS 250W	HPS 300W	HPS 350W	HPS 400W
Light Source	SMD LED								
Luminous Efficacy	>130lm/w								
Operation Temp.	-40 to +45°C								
CCT	2700K SW / 3000K WW / 4100K NW / 5000K DW / 5700K CW								
CRI	80+								
Life Span	50,000 hours at 25°C								
Voltage	100-277VAC/50-60HZ    200-480VAC available								
Driver	Internal Power Supply								
Dimming	Standard: Not dimmable ;								
Sensor	Standard: No sensor ;								
Remote Control	Standard: No remote ;								
Beam Angle	360°								
Cover	Transparent cover(default)								
Lamp Base	20W~60W:E26/E27/E39/E40/Ex39; 80W~150W:E39/E40/Ex39, If you want the E26/E27, we can have an additional conversion lamp base.								
PF	>0.95								
Warranty	5Years								

# DIMENSIONAL DRAWING

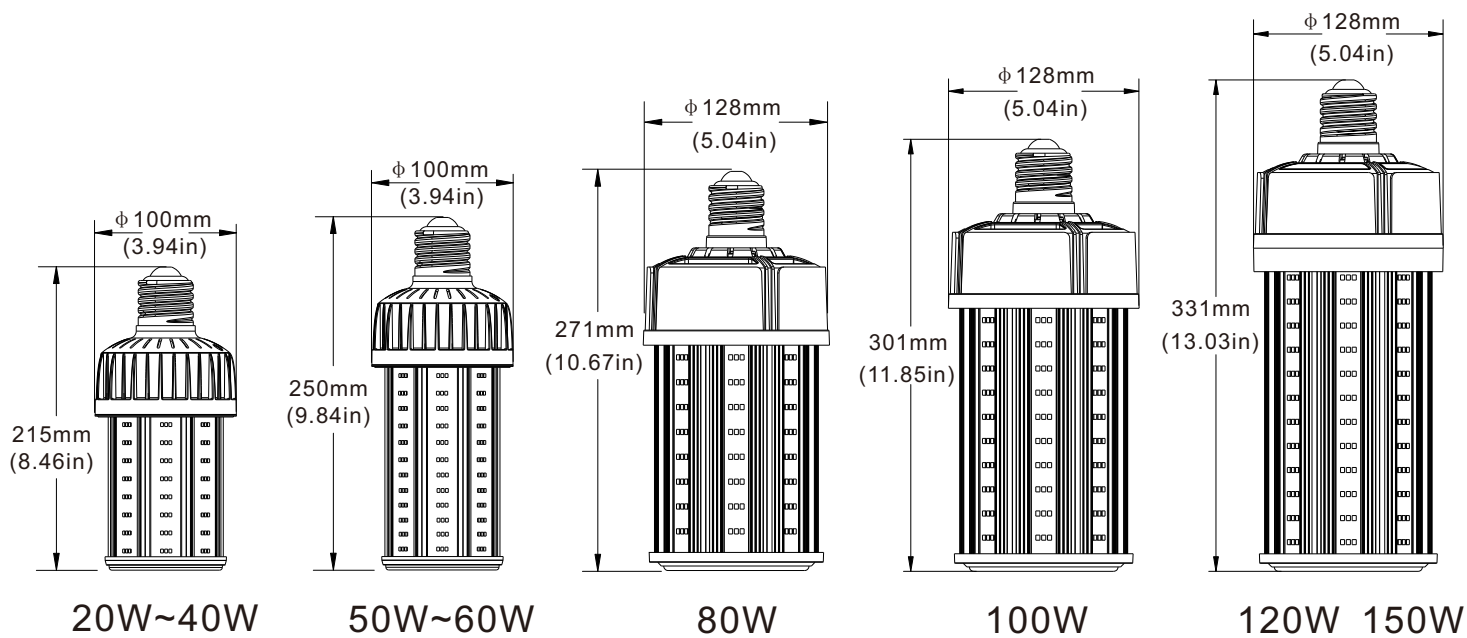

# LUMINOUS INTENSITY DISTRIBUTION

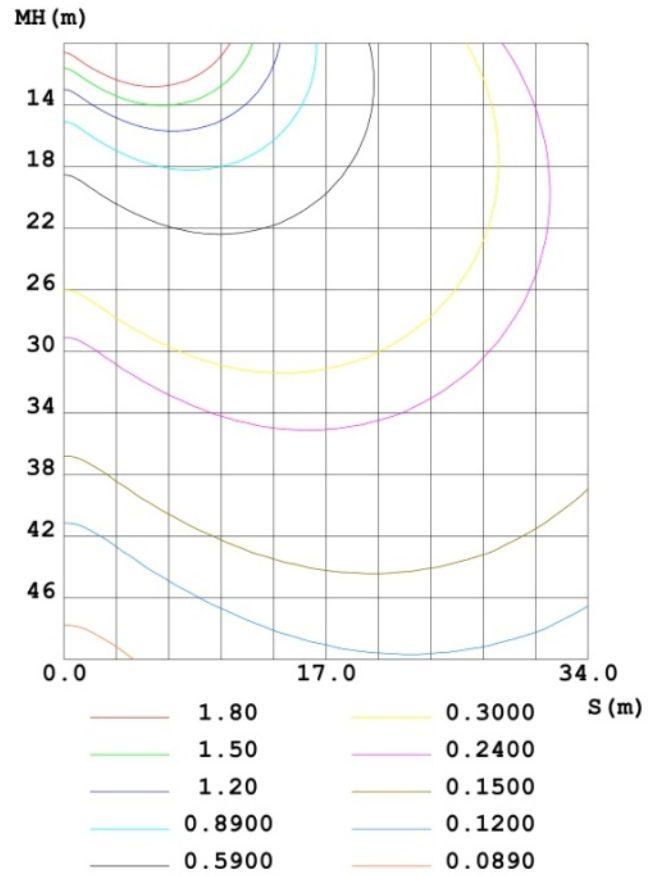
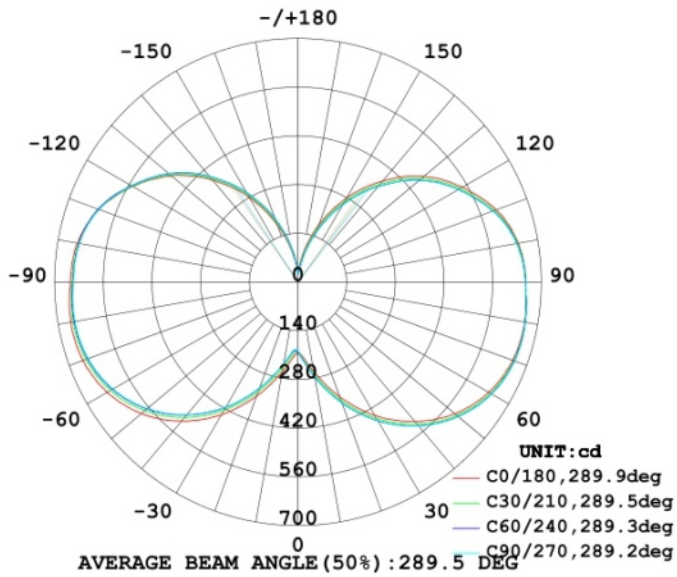

## PROJECTS

By using our 80W LED Corn Bulb to replace 250W Metal Halide bulb for garden hall path lighting fixtures, the customer is now able to save a lot per month from his electric bill.



Replace



80W LED = 250W MH

### Note:

- Don't take the LED lamp apart.
- The LED lamp must work under the right voltage according to the specification.
- Must remove the Ballast, Capacitor, Ignitor before installing our LED Light.

# INSTALLATION

Normally. The traditional lamp has the ballast or capacitor or ignitor, like HPS, MH.

## Replace E39/E40/Ex39 CFL

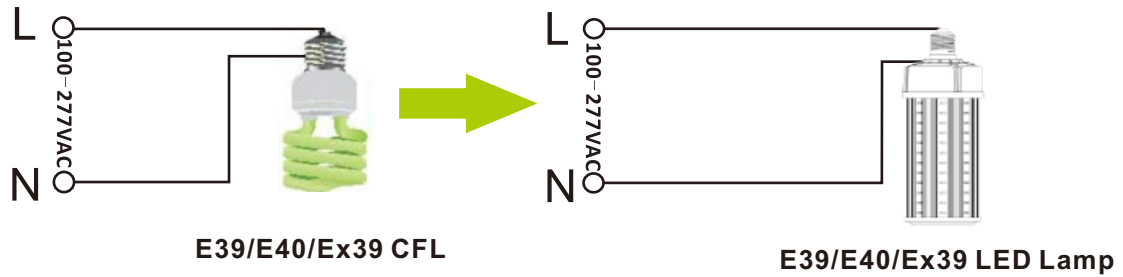

## Replace HPS/MH

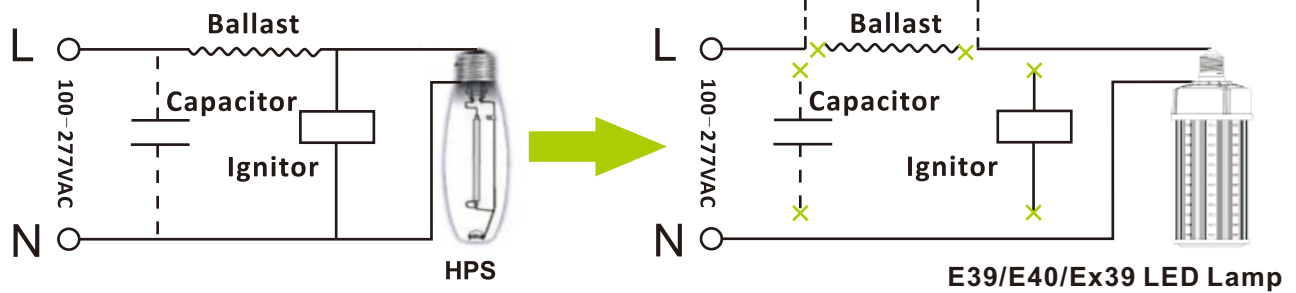

1. Remove the Ballast, Capacitor, Ignitor
2. Only need to put the L (live wire), N (null line) connected to the external power supply

When LED Corn Light installed in enclosed fixture, please make sure fixture diameter enough big for heat dissipation.

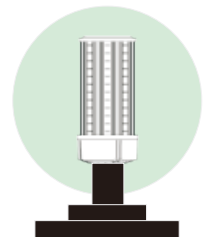

# PACKING INFO



Items	Packaging	Carton Size(mm) (L*W*H)	N.W	G.W	Volume weight
20W~60W	12pcs/CTN	540*490*340mm	10.4kg	11.5kg	21.0kg
80W	12pcs/CTN	750*500*360mm	18.2kg	19.5kg	28.0kg
100W	12pcs/CTN	750*500*360mm	19.1kg	20.5kg	28.0kg
120W&150W	12pcs/CTN	750*500*360mm	21.5kg	22.9kg	28.0kg