



LED Temporary String Lights

BRIGHTEN YOUR LIFE

NEW LED TECHNOLOGY THAT ALLOWS THE COEXISTENCE OF ENVIRONMENTAL PROTECTION AND ENERGY SAVING

Benefits

- 1.MH/HPS/HID/MHL/CFL lamp retrofit.
- 2.Come with metal cage, more safety and durable.
- 3.IP65 waterproof rating.
- 4.Each lamp with metal hook, flexible for easy intallation.
- 5.CE ROHS ISO listed.

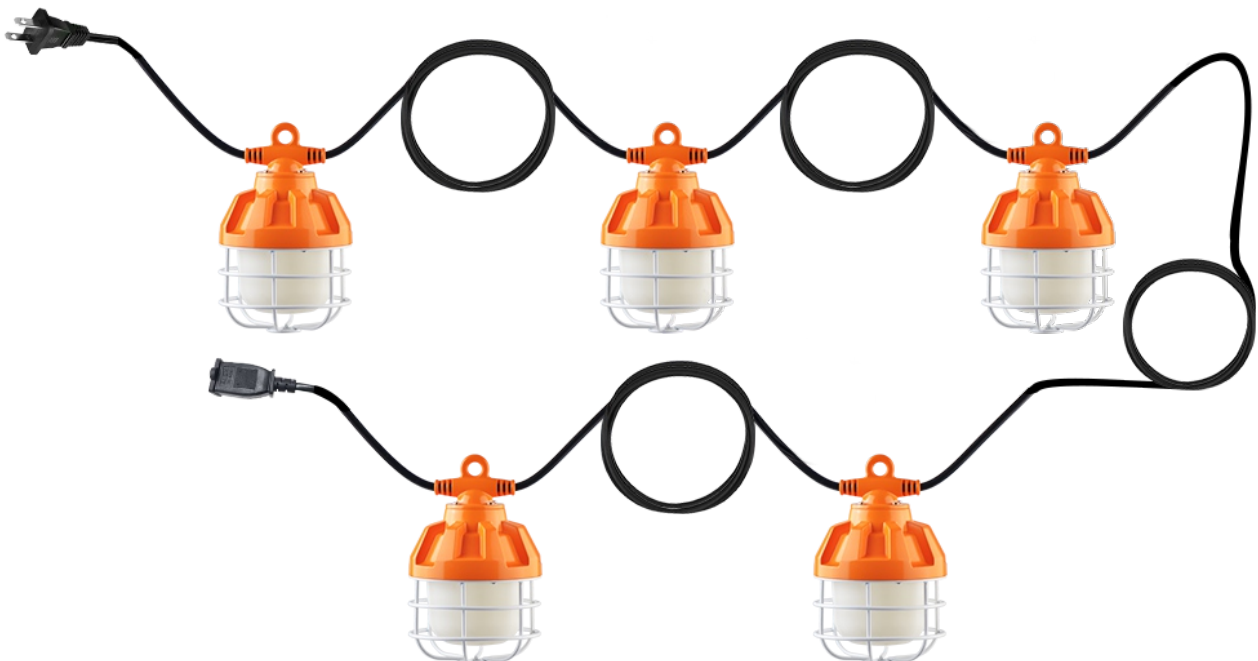

5 lights or 10 lights per string for option
(The number of light strings can be customized)

Features

1. Beam angle:360 degrees.
2. With metal cage,better protection on the light source.
3. 5 lights or 10 lights per bunch for option. Suitable to different demand of distant.
4. Light heads spaced 10 feet/3mts apart, same to traditional string work light.
5. 18 AWG power wire, one series connection can do 900W.
6. Green, energy saving, long and reliable life of 50,000 hours.
7. IP65 waterproof rating, protect the light well in outdoor application.
8. Wide colour availability in degrees Kelvin(K),2700-6700K.
9. Each lamp with metal hook, flexible for easy intallation.
10. Come with metal cage, more safety and durable.
11. Misty PC cover protect eyes better, anti-dazzle design.

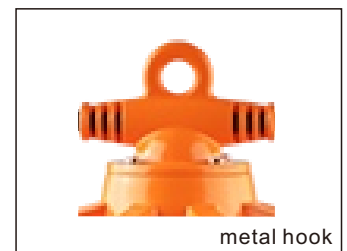
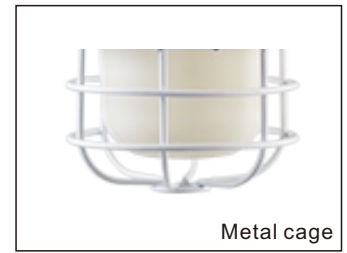

Application

1. Sports Light/Post Top Light.
2. Flood Light/Pole Light.
3. High/Low Bay Light
4. Roadway Light/Street Light/Billboard Light.
5. Other application roadway.

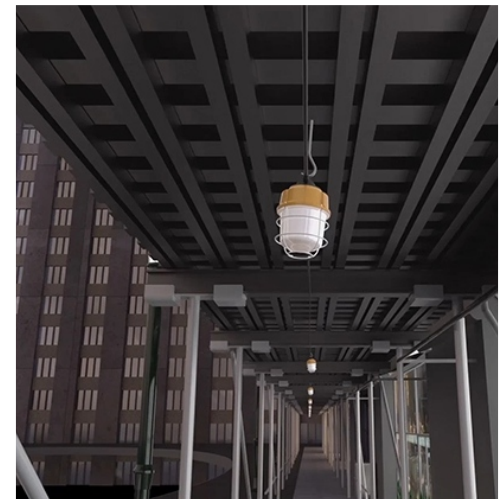

SPECIFICATIONS

Power	20W	100W	200W
Model	BB-HJD-20W-Q2	BB-HJD-100W-Q2	BB-HJD-200W-Q2
Luminous Flux	2200lm	11000lm	22000lm
Replacement	HPS 50W	HPS 300W	HPS 600W
Numbers Of Light String	1 LED light	5 LED lights per string	10 LED lights per string
Customers can choose the number of light strings according to their needs.			
Light Source	SMD LED		
Luminous Efficacy	>110lm/w		
Operation Temp.	-40 to +45°C		
CCT	2700K SW / 3000K WW / 4100K NW / 5000K DW / 5700K CW		
CRI	80+		
Life Span	50,000 hours at 25°C		
Voltage	100-277VAC/50-60HZ		
Driver	Internal Power Supply		
Dimming	NO		
Beam Angle	360°		
Lamp Base	Hook Install		
PF	>0.95		
Warranty	5Years		

DIMENSIONAL DRAWING

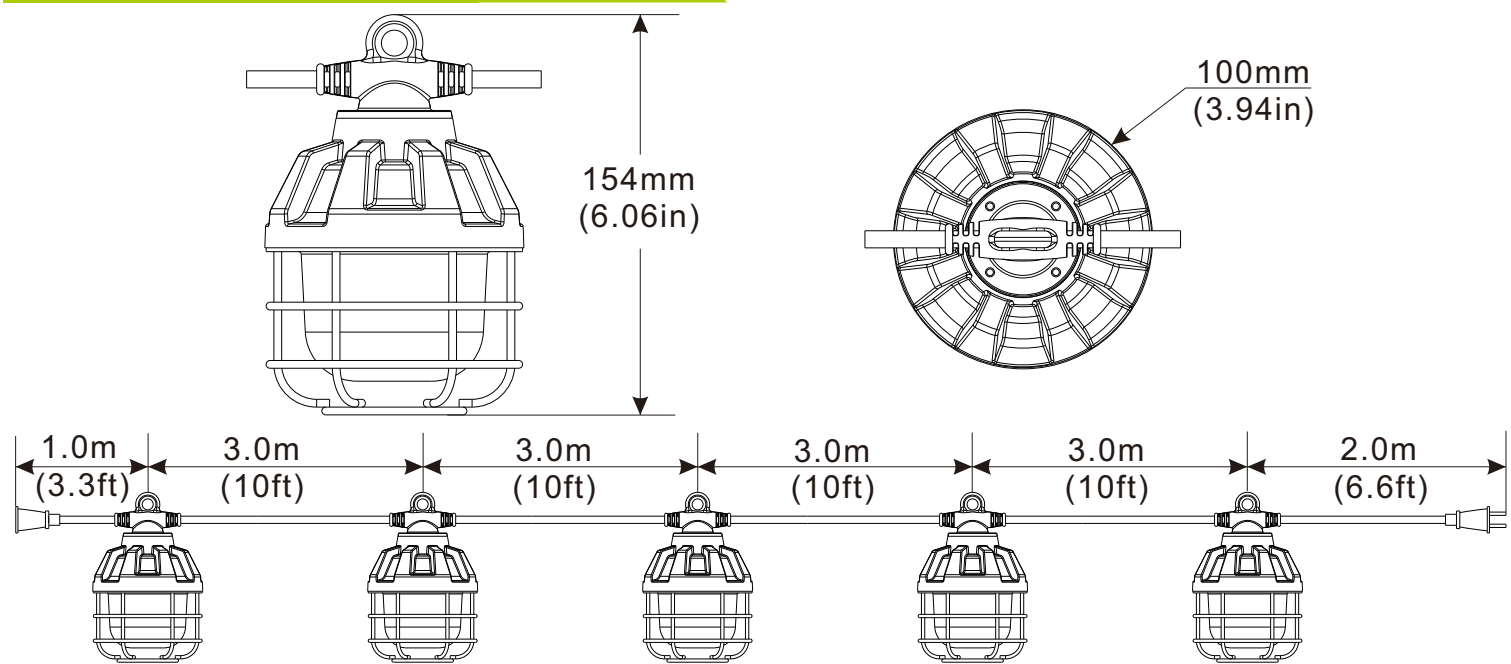

- Option 1: It has 5 LED light heads and comes with a 50ft AC cord, Light heads spaced 10feet/3meters apart.
- Option 2: It has 10 LED light heads and comes with a 100ft AC cord, Light heads spaced 10feet/3meters apart.
- Option 3: Customers can choose the number of light strings according to their needs.

LUMINOUS INTENSITY DISTRIBUTION

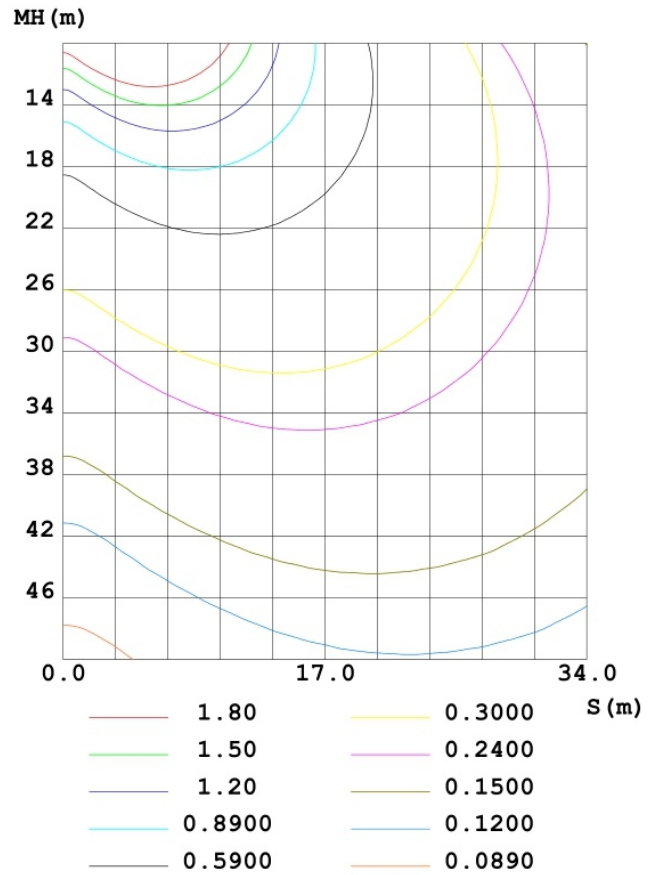
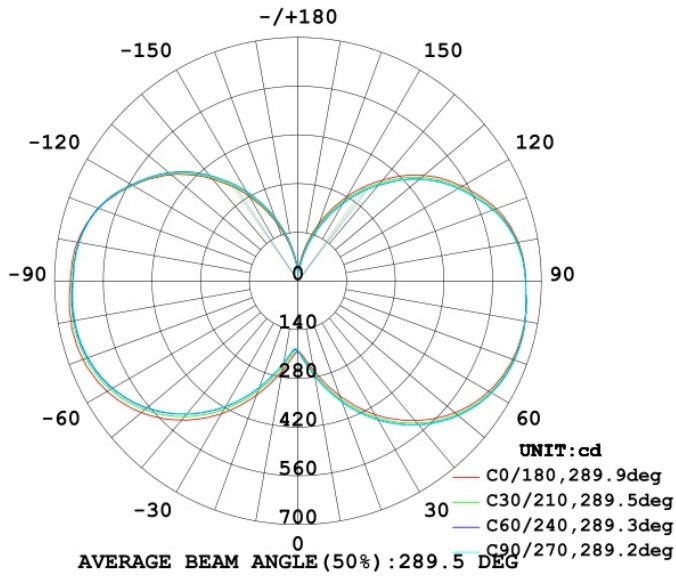

PROJECTS

By using our 100W LED Work lights to replace 300W Traditional Temporary Work Light, the customer is now able to save a lot per month from his electric bill.

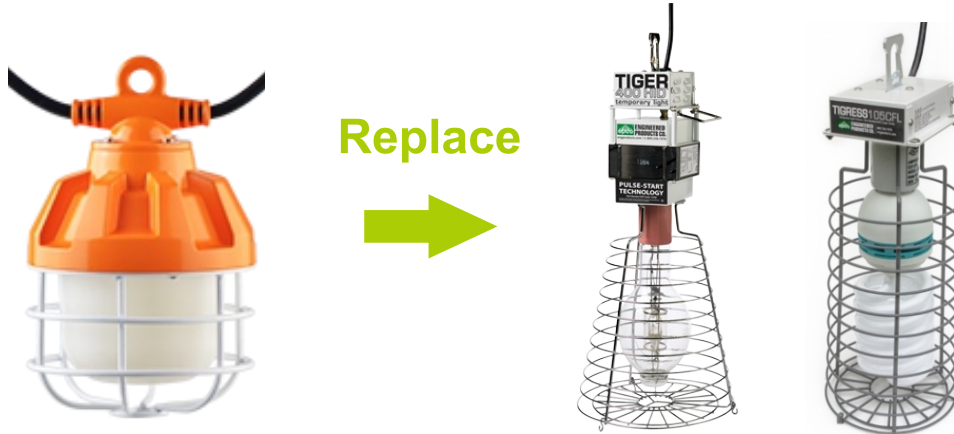

20W LED = 50W MH
100W LED = 300W MH
200W LED = 600W MH

Note:

- Don't take the LED lamp apart.
- The LED lamp must work under the right voltage according to the specification.
- Must remove the Ballast, Capacitor, Ignitor before installing our LED Light.

PACKING INFO



Items	Packaging	Carton Size(mm) (L*W*H)	N.W	G.W	Volume weight
20W 1 LED light	1pc/CTN	130*130*170mm	0.6kg	1.0kg	1.0kg
	5pcs/CTN	500*300*150mm	3.0kg	4.0kg	6.0kg
100W 5 LED lights per string	1pc/CTN	500*300*150mm	3.0kg	4.0kg	6.0kg