



# **Explosion Proof Light I Series**



**Industrial Field & Hazardous Locations**



# Applications

## Oil and Gas industry

- All petroleum production and refining
- Petroleum loading and transportation
- Petroleum storage and retail
- LNG industry

- All mining operations and service

## Chemical industry

- All types of paint facilities
- Chemical production and storage

## Ocean, marine and aerospace field

- Ocean platform operation facilities and structure
- Aerospace clean room and production
- Ocean vessel operations

## Metal treatment

- Steel and aluminum factories
- Pumping stations in any environment
- Metal smelting, foundry and fabrication

## Food and alcohol industry

- Flour and fine particle production and storage
- Food and distilling production
- Alcohol industry

Other high humidity, high dust, high temperature, vapor locations



# Explosion Protection

## Marking Atex

II2 G Ex db op is IIB T4/T5 Gb

II2 D Ex op is tb IIIC T135°C Db IP66

## Marking IECEX

Ex db op is IIB T4/T5 Gb

Ex op is tb IIIC T135°C Db IP66

## Marking UL844<sup>(North American)</sup>

Class I, Division 1, Groups C, D

Class I, Division 2, Groups A, B, C, D

Class II, Division 1, Groups E, F, G

Class II, Division 2, Groups F, G

Class III

## Marking Marine

UL1598, UL1598A

ABS

## Other Rating

IP 66

## Features

- Working Temperature: -40°C ~ +60°C.
- High quality SMT LED and Meanwell Driver.
- Light-weight design by aircraft aluminum.
- Heavy-duty and high impact resistance.
- Three connection cable entry points.
- Replaceable LED board and drivers.
- Integrated junction box for driver with emergency back up.
- Dimmable and battery back up function available.
- Marine rating powder coated appearance treatment.
- Up to 5 years limited warranty option.
- Emergency Battery back up to three hours.
- Various installation ways for different applications.
- Glass lens or Glass with polycarbonate lens to make bigger beam angle.



14

## Materials

- Housing: Die-casting Aluminum
- Lens: PC
- Hardware: stainless steel
- Mounting Bracket: stainless steel



# Specification

Model	Wattage	CCT	Voltage Options	Lumens	Warranty	CRI	Emergency Time(Optional)
EX-20W I2YZDA	20	2200K-7000K	AC100-277V AC200-480V DC12-36V	2800	5 years	>70	3 hours
EX-40W I2YZDA	40			5600			
EX-60W I2YZDA	60			8400			
EX-60W I4YZDA	60			8400			
EX-80W I4YZDA	80			11200			
EX-100W I4YZDA	100			14000			
EX-120W I4YZDA	120			16800			

"I2, I4"=Product code "Y"=D or N: Dimmable or Non-dimmable "Z"=CCT, from 2200~7000K.  
 "D"=Beam angle, D40 for 40°, D60 for 60°, D90 for 90°, D120 for 120°. A for cover info., blank for flat cover, C spherical cover.

# Packing Information

Model	Quantity/ Ctn	Length(cm)	Width (cm)	Height(cm)	Net weight(kg)	Gross weight (kg)
I2	1	77	34	26.5	12	14
I4	1	136	34	26.5	18.5	21.5

# Light Distribution

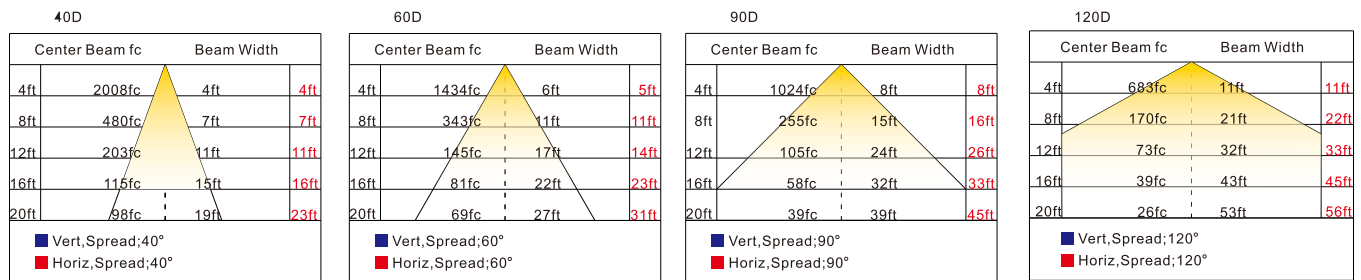

# Dimension Unit: mm or inch

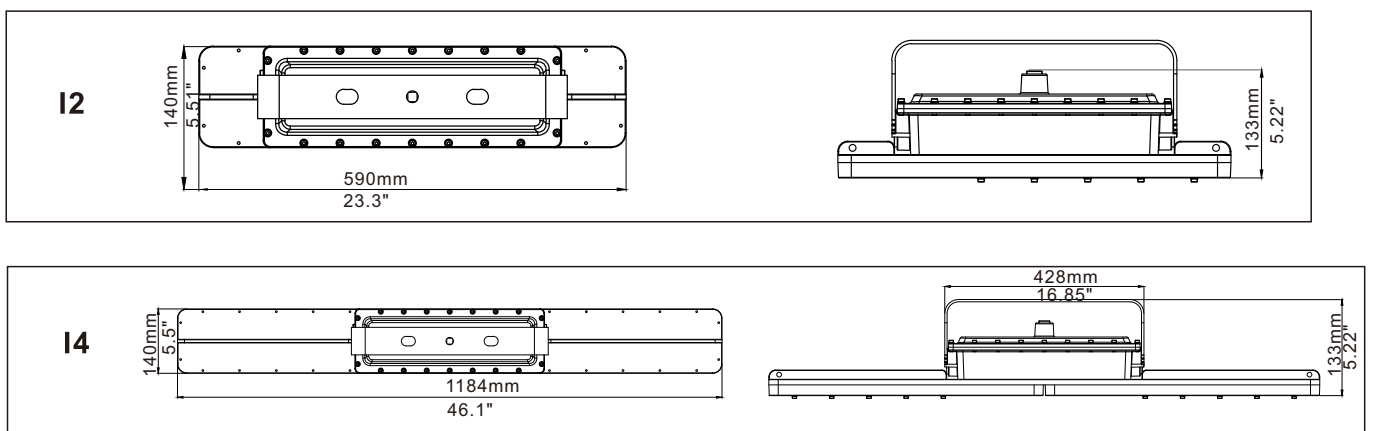

# Mounting

No.1 Ceiling Mounting

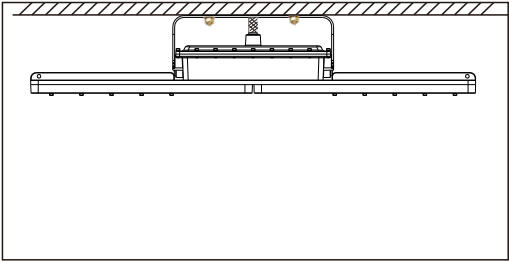

No.2 Pole Bracket Mounting

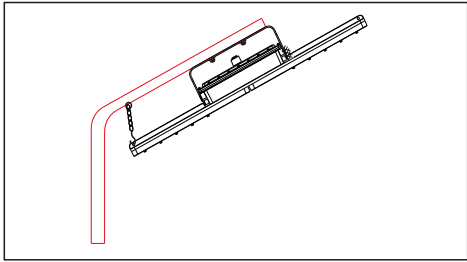

No.3 Wall Mounting

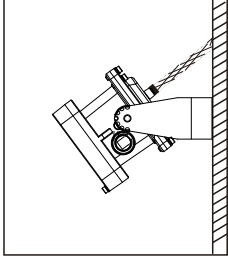

No.4 Chain Mounting

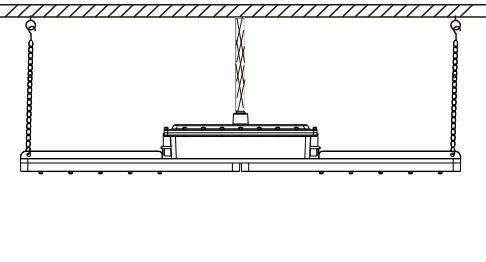

No.5 Pole Pendant Mounting

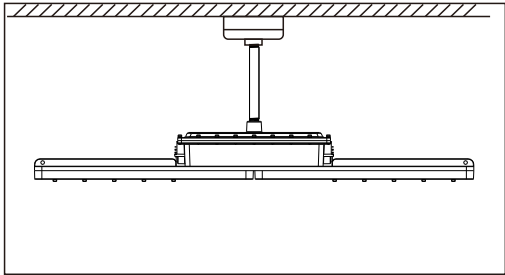

# Accessories

Junction Box



Bracket



Straight Pipe



Chain



Metal Conduit



Bended Pipe

